



CADS Revit to SCIA Engineer

Best practices

Contents

1	Installation	1
2	Work flow.....	2
2.1	Revit to SCIA Engineer.....	2
2.1.1	Export all analytical members.....	2
2.1.2	Export all structural members	3
2.1.3	Export members with both analytical and structural members.....	3
2.1.4	Export members with the option “all members”	4
2.2	SCIA Engineer to Revit.....	5
2.2.1	Import only analytical members	5
2.2.2	Import only structural members.....	5
2.2.3	Import both structural and analytical members.....	5
2.3	Roundtrip:	6
3	Revit model	7
3.1	Revit template.....	7
3.2	How to view the Analytical model	8
3.3	Creating analytical elements in Revit.....	8
3.4	Structural-Analytical Element Association.....	9
3.5	Creating a test model.....	9
3.6	Levels.....	10
3.7	Zero length elements	10
3.8	Openings in slabs or walls.....	10
3.8.1	Shaft openings.....	10
3.9	Dummy elements.....	11
3.10	Multiple slabs.....	11
3.11	Loads	11
3.12	Load panels	11
4	Mapping Tables.....	12
5	Configuration settings.....	13
5.1	Options.....	13
5.2	National Code.....	13
5.3	Mode of export	13
5.4	SCIA Engineer version	14
5.5	Mapping details	14
5.5.1	Revit family path	14

5.5.2	Mapping tables	14
6	Export / Import tools.....	16
6.1	Filter	17
6.2	Log files	17
6.3	Select changes.....	17
6.4	Import / Export limitations	18

1 Installation

The current version of **CADS Revit SCIA Engineer Link** works with **Revit 2023** and **Revit 2024**. You will also need a copy of **SCIA Engineer** installed on your system but it does not need to be authorised. **CADS Revit SCIA Engineer Link** needs to know the version of **SCIA Engineer** in order to create the correct version of the export file.

For full details and the installation file for **Revit** please go to <https://cads.co.uk/support-and-learning/release-notes/> and download the documents relating to the installation and use of the program in addition to this document.

Document	Description
Release Notes	This details the supported versions of Revit and SCIA Engineer and the enhancements and bug fixes to the latest version of CADS Revit SCIA Engineer Link.
Getting Started	CADS Revit SCIA Engineer Link configuration and basic usage notes.
Check List	Aide memoir when creating projects, this list should be submitted for all requests for support on CADS Revit SCIA Engineer Link.

Please refer to this document before installing or using the software.

Note:

We suggest that you uninstall the previous version of the **link** before starting the installation of the latest version of **CADS Revit SCIA Engineer link**.

2 Work flow

In Revit 2023, the analytical model feature has been modified significantly. The approach for generating the analytical model is now changed from Derived analytical model (till Revit 2022) to Contextual analytical model. As there is a change in the analytical model in Revit 2023, the Revit model might have only structural members or only analytical members, or a mix of both. For more details about Structural analytical modelling in Revit, please visit [Help | Structural Analytical Modeling for BIM Coordination | Autodesk](#).

2.1 Revit to SCIA Engineer

You might have modelled only structural elements or only analytical elements or might have modelled both the elements in Revit. You may need to export “all analytical” members or “all structural members” or “Members with both analytical and structural members” or “all” the elements. CADS Revit SCIA Engineer tries to handle the following possible workflows while exporting the model from Revit to SCIA Engineer.

2.1.1 Export all analytical members

- You create or generate the analytical model in Revit;
- You export the model using the option “Elements to export” with the option set to “All analytical”;
- The application will export all analytical elements to SCIA Engineer irrespective of its association with the structural model.
 - The program will not export the structural elements which are not associated to any analytical member;
 - The program will update only the analytical model, as it doesn’t have any information about the structural model in Revit;
 - When multiple analytical elements are associated with single structural element, all the analytical elements will be exported;
 - When multiple structural elements are associated with single analytical element, only the associated analytical element will be exported and all the structural elements will be ignored;
 - If the Structural role of an analytical panel is set as “Panel” and the property “Export panel as load panel” is set to “true”, the analytical panel will be exported as “load panel” irrespective of its association with the structural element.
- The properties defined in the analytical members are exported to SCIA Engineer;
- The associated elements like boundary conditions, member end fixities, and loads will also be exported to SCIA Engineer;
- Once the model has been exported to SCIA Engineer, the user can add/modify the above properties needed for analysis and proceed with the calculations;
- You can update the analytical model in Revit model by importing the model from SCIA Engineer.

2.1.2 Export all structural members

- You create the model in Revit;
- You export the model using the option “Elements to export” with the option set to “All structural”;
- The application will export all structural elements to SCIA Engineer irrespective its association with the analytical model;
 - The program will not export any analytical elements even if they are associated with the structural elements;
 - The program will update only the structural model, as it doesn’t have any information about the analytical model in Revit;
 - When multiple analytical elements are associated with single structural element, only the structural will be exported and all the analytical elements will be ignored;
 - When multiple structural elements are associated with single analytical element, all the structural elements will be exported.
- The properties defined in the analytical elements will not be exported to SCIA Engineer. Hence the associated elements like boundary conditions, member end fixities, and loads will not be exported to SCIA Engineer;
- Once the model has been exported to SCIA Engineer, the user can add/modify the above properties needed for analysis and proceed with the calculations;
- You can update the structural/physical model in Revit by importing the model from SCIA Engineer.

2.1.3 Export members with both analytical and structural members

- You create the model in Revit;
- You generate or create the analytical model and associate them with the structural model in Revit;
- You export the model using the option “Elements to export” with the option set to “With both analytical and structural”;
- The application will export only the structural elements which are associated with the analytical model to SCIA Engineer;
 - When multiple analytical elements are associated with single structural element, all the analytical elements will be exported with the properties of associated structural element;
 - When multiple structural elements are associated with single analytical member, the link will export the analytical element with the properties of the first associated structural element and all other structural elements will be ignored;
 - If the Structural role of an analytical panel is set as “Panel” and the property “Export panel as load panel” is set to “true”, the analytical panel will be exported as “load panel” irrespective of its association with the structural element. The associated structural element will be ignored with a warning message.

- The program will not export analytical members that are not associated with structural elements or structural elements without corresponding analytical members;
- The program will update both the structural model and its associated analytical model;
- The geometry of members and the properties like material, cross-section and section rotation will be read from analytical model and the additional properties like alignment, composite deck info are read from structural properties;
- Boundary conditions, member end fixities, and loads if defined in Revit will be exported;
- Once the model has been exported to SCIA Engineer, the user can add / modify the above properties needed for analysis and proceed with the calculations;
- You can update the structural and analytical model in Revit model by importing the model from SCIA Engineer.

2.1.4 Export members with the option “all members”

- You create the model in Revit;
- You generate or create the analytical model and associate them with the structural model in Revit;
- You export the model using the option “Elements to export” as “All”;
- The application will export all the elements “Structural and analytical”. When they are associated the geometry of members and the properties like material, cross-section and section rotation will be read from analytical model. The additional properties like alignment, composite deck info are read from structural properties;
- When multiple analytical elements are associated with single structural member, the program will export all the analytical elements as individual elements to SCIA. In this case, the structural properties of the associated element are applied to all the analytical elements;
- When multiple structural elements are associated with single analytical member, the program will export the analytical element with the properties of the first associated structural element. All other structural elements will also be exported with their own geometry and its properties;
- If the Structural role of an analytical panel is set as “Panel” and the property “Export panel as load panel” is set to “true”, the analytical panel will be exported as “load panel” and the associated structural element will be exported as “Floor”.
- If the model has only structural or only analytical, the members will be exported by reading their respective properties;
- Boundary conditions, member end fixities, and loads if defined in Revit will be exported;
- Once the model has been exported to SCIA Engineer, the user can add / modify the above properties needed for analysis and proceed with the calculations;
- You can update the Revit model by importing the elements from SCIA Engineer.

2.2 SCIA Engineer to Revit

Models created in **SCIA Engineer** are based on the analytical centre line. When the model is transferred from **SCIA Engineer** to **Revit** the members will be transferred based on the analytical stick model created in **SCIA Engineer**.

Member offsets and eccentricities will be transferred if they are supported by the particular elements in **Revit**. Where these offsets and eccentricities are not supported, a warning message will be issued in the transfer log file in **CADS Revit SCIA Engineer link**. These individual elements will need to have the eccentricities applied manually in **Revit** to create the correct presentation model and corresponding general arrangement drawings.

CADS Revit SCIA Engineer tries to handle the following possible workflows while importing the model from SCIA Engineer to Revit.

2.2.1 Import only analytical members

- You create the model in SCIA Engineer;
- You import the model using the option “Create elements in Revit” as “Analytical”;
- The application will create/ generate only analytical elements in Revit;
- Load panels will be imported as “Analytical panels” if the option “ignore load panels” is set to false;
- The associated elements like boundary conditions, member end fixities, and loads will also be imported from SCIA Engineer;
- The program will not import the eccentricity or composite slab info from SCIA Engineer as these properties cannot be defined in Analytical model of Revit.

2.2.2 Import only structural members

- You create the model in SCIA Engineer;
- You import the model using the option “Create elements in Revit” as “Structural”;
- The application will create/ generate only structural elements in Revit;
- The program will import the eccentricity or composite slab info from SCIA Engineer as these properties can be defined in Structural model of Revit.
 - The analytical model entities like boundary conditions, member end fixities, and loads will not be imported from SCIA Engineer.

2.2.3 Import both structural and analytical members

- You create the model in SCIA Engineer;
- You import the model using the option “Create elements in Revit” as “Structural and analytical”;

- The application will create/ generate the structural and analytical elements in Revit. The analytical elements will be associated to structural elements in Revit;
- Load panels will be imported as “Analytical panels” and no associated structural element will be created;
- The associated elements like boundary conditions, member end fixities, and loads will also be imported from SCIA Engineer;
 - The program will also import the eccentricity or composite slab info from SCIA Engineer.

2.3 Roundtrip:

Roundtrips in general will follow the one-way options described above with the additional requirement of keeping track of and updating the Revit model with changes made in SCIA Engineer. The elements in Revit can be updated only based on the option chosen during export.

3 Revit model

Listed below are some suggestions that will help optimise the transfer of the **Revit** model to **SCIA Engineer**.

3.1 Revit template

You may use your customised **Structural** template but ensure that the customised template is created from a default **Revit Structural** template deployed by a **Revit** installation. The template should be configured to use the same *Units* as the **SCIA Engineer** model.

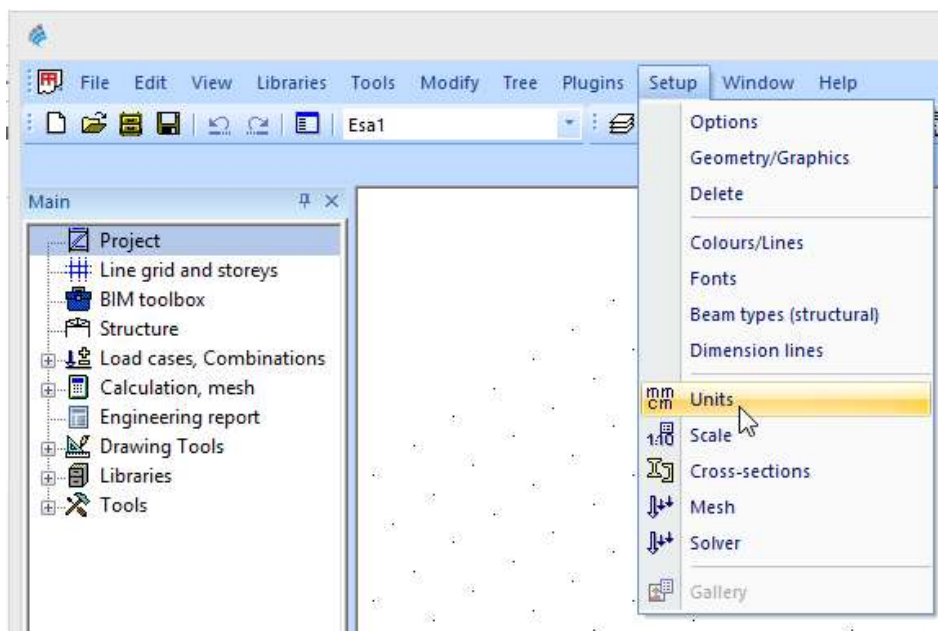

Figure 3-1: SCIA Engineer - Units

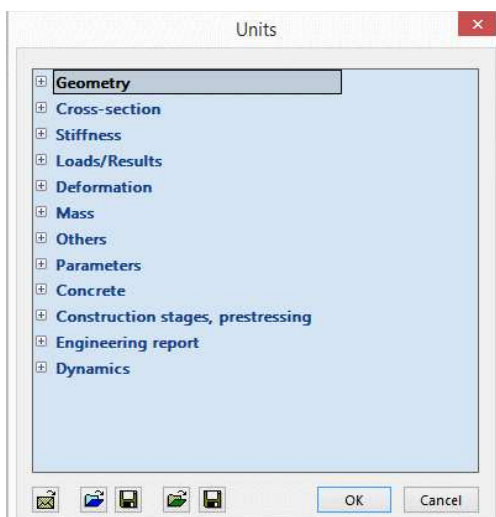

Figure 3-2: SCIA Engineer – Units dialog

It is recommended that you upgrade your customised template file when migrating to a higher version of **Revit**.

3.2 How to view the Analytical model

The model transfer to **SCIA Engineer** is based on the Analytical Stick Model created in **Revit**. You can view the analytical model in Revit Structure by going to the *Properties* dialog and selecting the *Visibility and Graphics Overrides* then clicking on Edit and switching on the Analytical Model. If required, you can disable the *Model Categories* to give a clearer view of the Analytical Model.

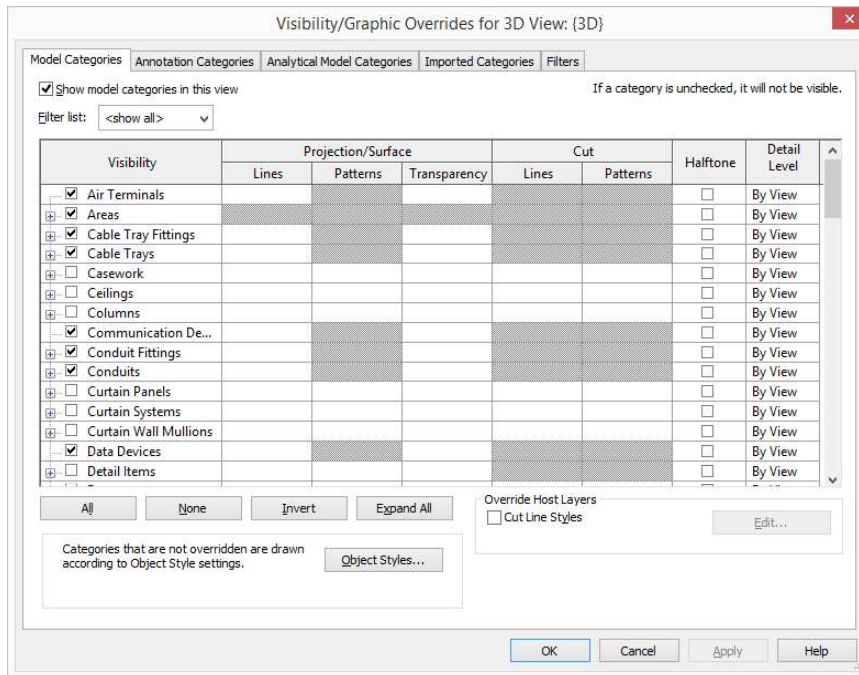
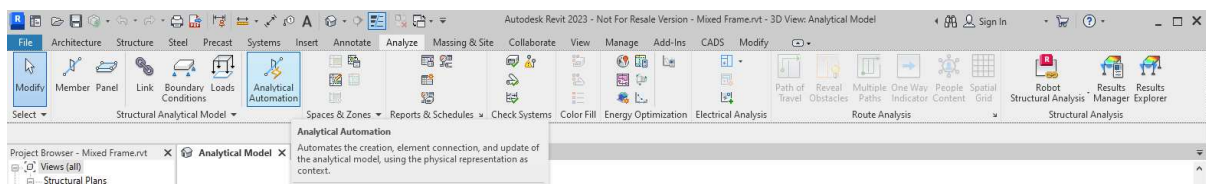

Figure 3-3: Revit Structure - Visibility/graphics overrides

3.3 Creating analytical elements in Revit

When a physical model is present, the user can use Analytical automation tool to generate analytical elements from physical members.



This tool is a Dynamo script, which generates the analytical elements from the physical model.

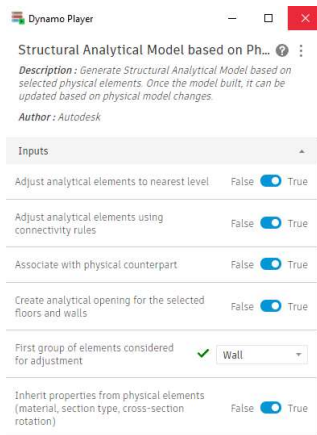

Alternatively, individual analytical elements may be created by using the Analytical member or Analytical panel command. Once created these elements may be associated with physical members, or left as they are without any association with a physical member.

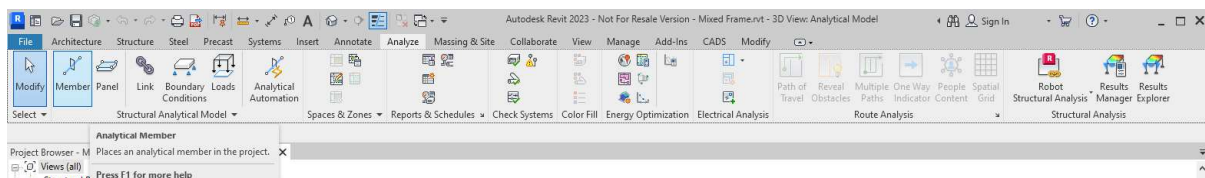

3.4 Structural-Analytical Element Association

In Revit 2024, you can create multiple associations between structural and analytical models (i.e.) You can associate multiple analytical panels or members to a single structural object or vice versa. For more details about physical - analytical element association in Revit, please visit [Help | Custom Physical-Analytical Element Association | Autodesk](#).

3.5 Creating a test model

Before using the **CADS Revit SCIA Engineer link** on a major project, it would be wise to become familiar with the software by creating a test model. A few key points to look for:

1. This model should incorporate the structural features you wish to specify in your projects so that it will allow you to test the round trip from **Revit** to **SCIA Engineer** and vice versa. For example, if you are using a custom *Revit Structure family (*.RFA file)* then it will be useful to create a member using the *Revit Structure family (*.RFA file)* and exporting it to **SCIA Engineer** to check if the cross-section type and member eccentricities are transferred correctly.
2. Ensure that the analytical model is in the correct position and connected before attempting to export it to **SCIA Engineer**.
3. Most importantly, make sure that the building you model in **Revit** is one that you could model in **SCIA Engineer** and is a valid model that can be analysed. For example, if the members are not connected in **Revit** then the same problem will be reflected in the **SCIA Engineer** model too.
4. The **Revit** model must be saved before attempting to export it to **SCIA Engineer**.

3.6 Levels

Ensure that the *Base Level* and *Top Level* of columns & walls are set to the nearest **Revit Level**. Otherwise **SCIA Engineer** may not be able to resolve the position of the element correctly. If the vertical offsets (*Top Offset* and *Base Offset*) in **Revit** are applied, do not allow them to cross another *Level*. Floor slabs should also be assigned to the nearest *Level*, otherwise the slab position in **SCIA Engineer** will be incorrect.

3.7 Zero length elements

If there are elements on the model which have no physical length, **CADS Revit SCIA Engineer Link** will flag them in the log file while exporting the model to **SCIA Engineer**. You may need to remove them from the model before trying to export to **SCIA Engineer**.

3.8 Openings in slabs or walls

Where an opening coincides with the edge of a slab, or a wall, it is best practice to define the boundary of the slab around the opening.

When a hole is required within the perimeter of a slab or wall do not use the edit boundary option to add the hole. Instead, you may create the holes using the “Opening option”.

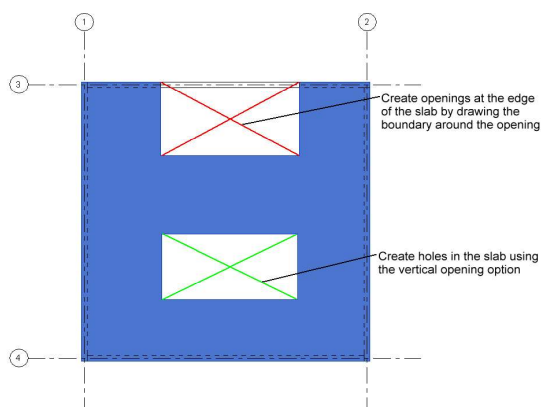

Figure 3-4: Revit– Slab openings

Owing to application limitations, it is not possible to import changes to the slab boundary in **SCIA Engineer** if the number of nodes is modified. It is best practice to use the *Opening* option whenever possible. If you are modelling analytical panels, it is recommended to create analytical openings along with the panels in Revit.

3.8.1 Shaft openings

In Revit it is possible to define an opening passing through the entire height of a building or through selected levels using the shaft opening option. These openings are transferred from Revit to SCIA Engineer as individual openings as there is no associated type for such an opening in SCIA Engineer.

When shaft openings are defined in Revit, care should be taken while updating the model from SCIA Engineer. It is recommended to set the option *Update 2D member openings* to “No” during import, otherwise the openings will be lost on import. An alternative to avoid the issue is to define them as individual openings in Revit rather than using the shaft opening option.

From Revit link v3.1 onwards, any change done to the shaft openings in SCIA Engineer will be automatically ignored on import to avoid the loss of opening during round trip.

3.9 Dummy elements

A dummy element is a short structural element used to join adjacent members that do not line up well. Dummy elements will not be exported from **Revit** to **SCIA Engineer** and will be shown in the transfer log file. Rather than use a dummy element, we suggest that you join the awkward connections with either model or detail lines.

3.10 Multiple slabs

While creating multiple slabs in Revit it is necessary to create them using individual actions in Revit rather than continuing the same command. This will ensure the slabs are identified individually. Otherwise they could be lost on export.

3.11 Loads

In Revit 2024, the loads can be applied only on analytical elements (Host). Loads created without a host (which was possible in the older versions of Revit) will not be exported. Free loads applied in SCIA Engineer will not be imported in Revit. For details about creating and applying structural loads in Revit, please visit [Help | Loads | Autodesk](#).

In Revit, all the load components can be specified using a single load, but in SCIA all these components will be treated as individual loads.

Point loads created using “Repeat” option in SCIA Engineer will get imported as individual loads in Revit and update of such loads is not possible.

In order to minimise chances of error during update it is recommended to create each component of the load separately.

3.12 Load panels

If you would like to export the “Analytical panels” as “Load panels” in SCIA Engineer, set the following properties:

- Structural role as “Panel”
- Analytical panel as Load panel to “Yes”, and
- Ignore load panels as “No”.

4 Mapping Tables

The standard cross section and material libraries in both **Revit** and **SCIA Engineer** are comprehensive but are labelled differently. The materials and cross sections are being mapped between the applications using mapping databases. The pre-installed database contains the mapping for materials, cross-sections and Profile sheets of Revit families and its types with equivalent SCIA Engineer entities.

Most of the standard materials, sections, profiles will be automatically mapped between SCIA Engineer and Revit families. But in some cases, you might modify the standard families or in other cases use non-standard materials, sections and profiles. In such instances, it is necessary to map them prior to export / import. The details of mapping will be added into the user table (database) and will be used for the subsequent export/import process.

The command “Mapping tables” in the ribbon could be used to map the materials, families and profiles prior to export/import the model to/from **SCIA Engineer**.

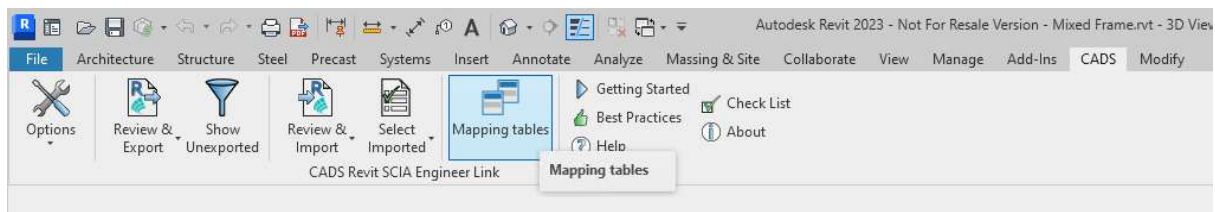

You may choose the option “Map all document sections/materials” button to map the materials, sections, profiles used in the document. The application will read and automatically map / suggested the appropriate equivalent objects. Once all the materials, sections and profiles are mapped, they will be added into the current database. You can save the database and share it across different users.

Alternatively, you may load any existing databases using the option “Import database” and use them prior to export or import. You are also provided with the options to add / delete the mapping.

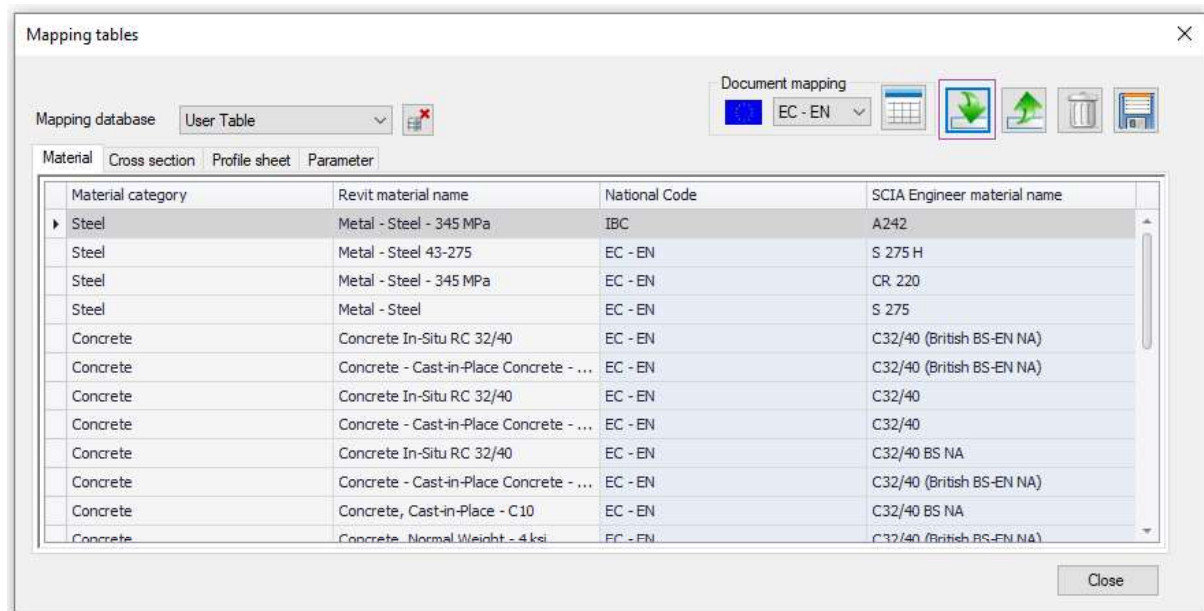

For full details on all the options in the mapping tables, please refer to the Help document.

5 Configuration settings

The settings applied in the **CADS Revit SCIA Engineer Link** will affect the way the model is transferred between **Revit** & **SCIA Engineer**.

5.1 Options

Generally, the settings inside the Options dialog box should be set-up as follows with a few exceptions that are explained in the subsequent section.

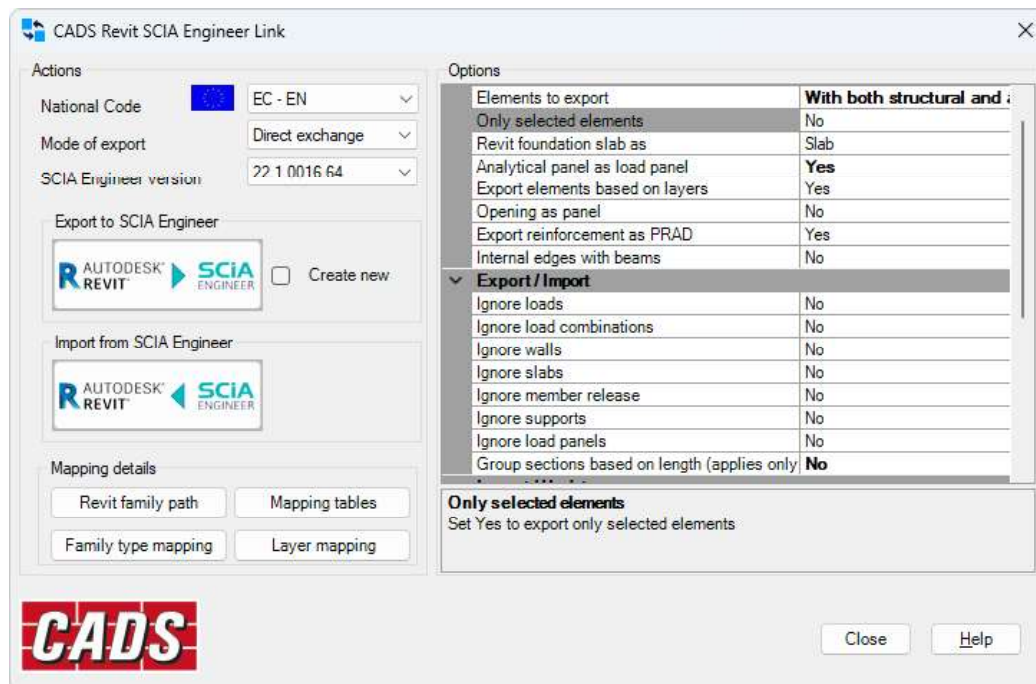

Figure 5-1: CADS Revit SCIA Engineer Link - Options dialog

5.2 National Code

Make sure that the *National Code* in **CADS Revit SCIA Engineer Link** matches the *National Code* set in **Revit** and **SCIA Engineer**. The material mapping is primarily dependent on the selected National code.

5.3 Mode of export

If you have an authorised copy of **SCIA Engineer** on your system, setting this option to “Direct Exchange” will mean that **SCIA Engineer** will be automatically started and your model will be loaded into the program. Setting the option to “file Exchange” will mean that a transfer file will be created in the same folder as your **Revit** model (unless you specify a different location). The transfer file will have the extension *.R2S. The transfer file can be opened inside **SCIA Engineer** using either the *File-> Import* option or the *File -> Update* option.

5.4 SCIA Engineer version

You will not be able to use the link software unless you configure the version of **SCIA Engineer** that is installed on your system. Click on “SCIA Engineer version” and browse to the location of your Esa.exe file.

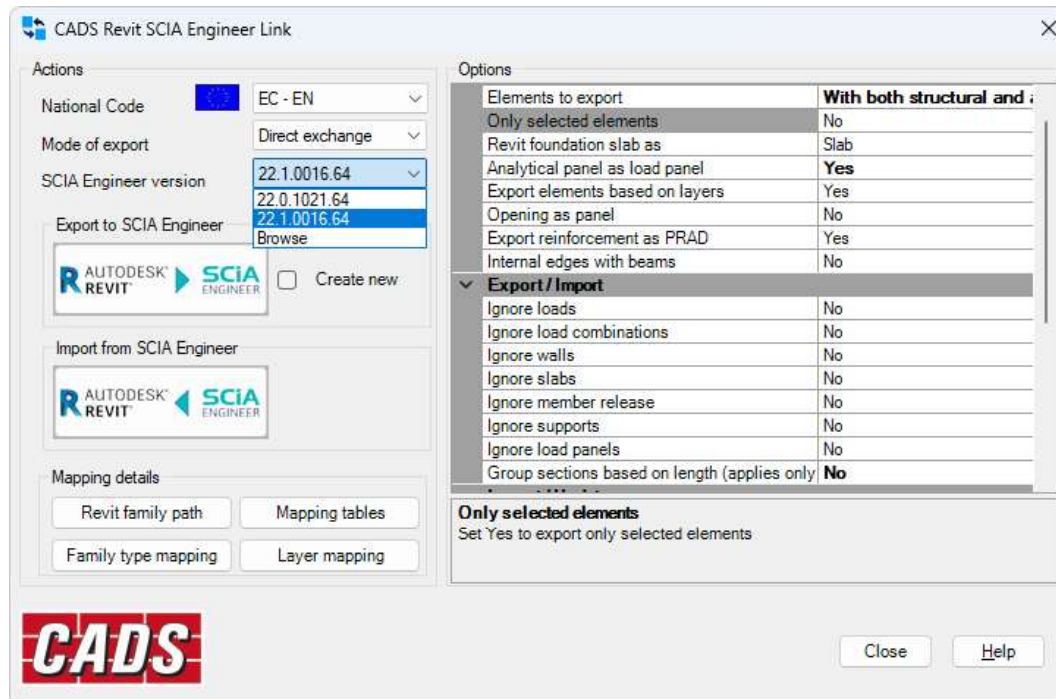

Figure 5-2: CADs Revit SCIA Engineer Link - SCIA Engineer version

5.5 Mapping details

CADs Revit SCIA Engineer link is being shipped with a pre-installed mapping database which matches cross-sections and materials between **SCIA Engineer** and **Revit**. The database contains the mapping for different Revit families and its types with SCIA Engineer sections. The database files are being prepared primarily based on the content libraries of Revit families.

5.5.1 Revit family path

If your installation of **Revit** does not have the families installed in the default location on your hard drive you can use this option to configure the path to the libraries. The default location for the families on your hard drive is **C:\ProgramData\Autodesk\RVT 20xx\Libraries\...**

5.5.2 Mapping tables

This dialog, details the Standard mapping tables that are shipped with the **CADs Revit SCIA Engineer Link** and the user tables. Standard mapping tables illustrates the default **Revit** families (Materials, Profile sheet and Virtual joists) linked to the corresponding default **SCIA Engineer** materials/sections.

Mapping tables

Mapping database: General-Materials

Material category	Revit material name	National Code	SCIA Engineer material name
Concrete	Concrete Cast-in-Place - C20	BS	C16/20
Concrete	Concrete Cast-in-Place - C25	BS	C20/25
Concrete	Concrete Cast-in-Place - C30	BS	C25/30
Concrete	Concrete Cast-in-Place - C40	BS	C32/40
Concrete	Concrete Cast-in-Place - C50	BS	C40/50
Concrete	Concrete Cast-in-Place - C60	BS	C50/60
Steel	Steel 43-275	BS	Grade 43
Steel	Steel 43-355	BS	S355
Steel	Steel 50-355	BS	Grade 50
Steel	Steel 51-275	BS	S275
Steel	Steel 55-450	BS	Grade 55
Steel	Steel 64-460	BS	S460

Figure 5-3: CADs Revit SCIA Engineer Link - Mapping Tables

For full details on mapping tables, please refer to the Help file.

6 Export / Import tools

On the first attempt to export the model to **SCIA Engineer** after you have checked the analytical model, it is recommended that you open the *Options* dialog and check the configuration settings as explained in [Section 5](#) above. It is recommended to “*Purge and Save the Model*” before Exporting the Model to SCIA. The purge command will help to reduce the size of the **Revit** model and is available from the *Manage* tab.

Select the *Export to SCIA Engineer* option.

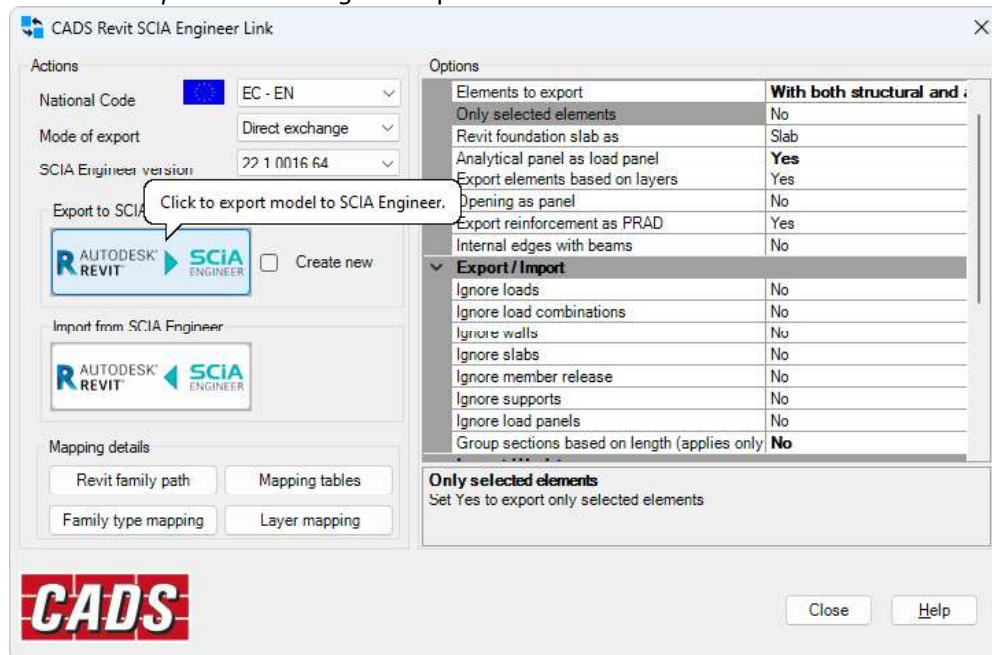

Figure 6-1: CADs Revit SCIA Engineer Link – Export to SCIA Engineer

The Log dialog is displayed and **CADs Revit SCIA Engineer Link** will read the **Revit** model, it will make a list of the total number of items from each category that is to be exported.

If **CADs Revit SCIA Engineer Link** encounters a material/section that is not mapped, you will need to manually map the equivalent objects.

On completion of the export routine, the Log dialog shows a summary of the number of items exported. You can save a log file which can be opened in a text editor to review the transfer.

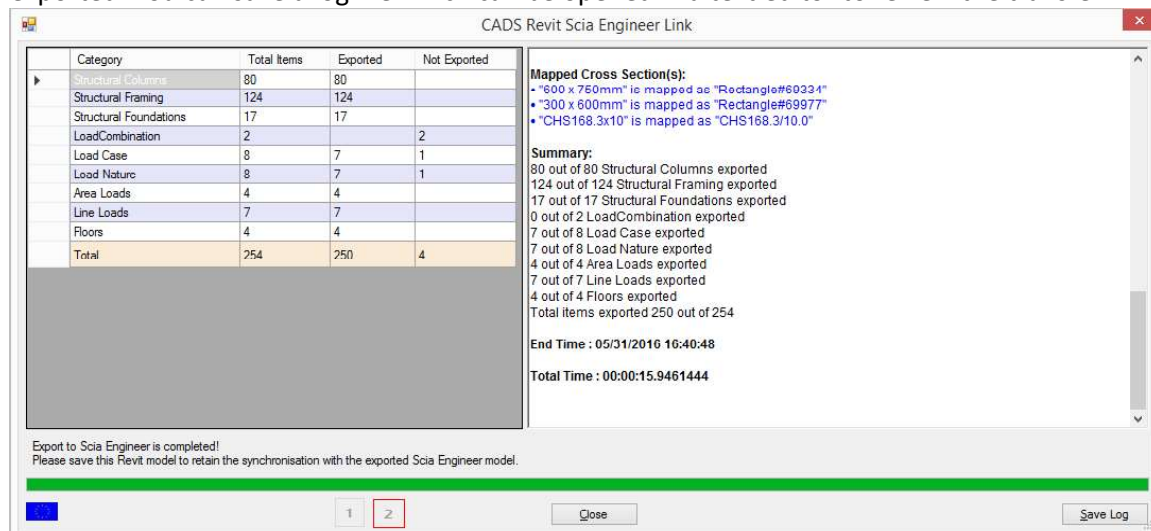

Figure 6-2: CADs Revit SCIA Engineer Link - Model exchange log

6.1 Filter

The filter option will allow you to locate any elements in the Revit model that have not been exported to **SCIA Engineer**.

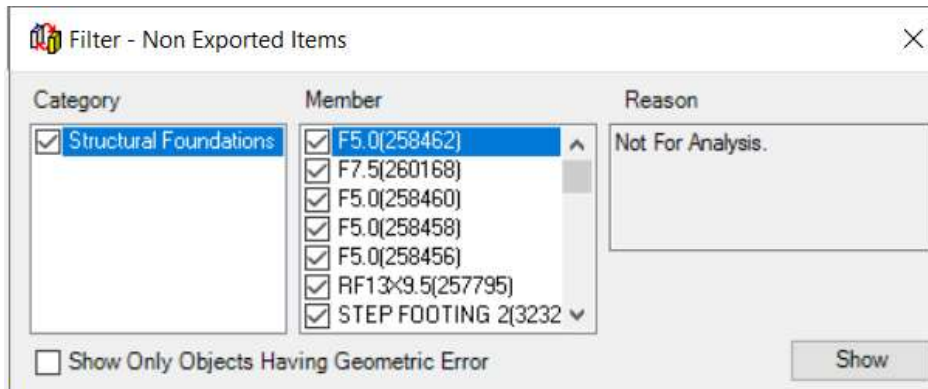

Figure 6-3: CADs Revit SCIA Engineer Link - Filter - Non Exported Items

Tick the elements you want to review and then click the show option; they will be highlighted in your **Revit** model.

6.2 Log files

The *Log* file is a text file which itemises each element that has been transferred between **Revit** and **SCIA Engineer**. It details the section / material and its mapping. Elements that have not been successfully transferred are shown in red. At the end of the transfer of the model from **Revit** to **SCIA Engineer** and/or vice versa you are given the option to save this file and review it.

The *Log* file will show the *Revit ID* number of an element that has not transferred to/from **SCIA Engineer**. You can use the *Select by ID* command (*Manage* Tab) to highlight and investigate these elements in the **Revit**.

6.3 Select changes

This option will help you to review any changes that have been made to the **Revit** model when you import the model from **SCIA Engineer**. In the diagram below the section size of the concrete column was increased. Choosing the *Section Size* option on the *Select Changes* command will highlight the amended column in **Revit**.

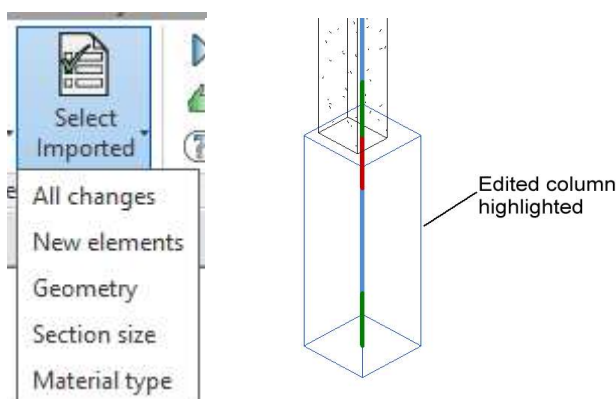

Figure 6-4: CADs Revit SCIA Engineer Link - Select Changes

6.4 Import / Export limitations

Refer to the Help pages in **CADS Revit SCIA Engineer Link** for the full list of items supported & unsupported in **Revit** and the corresponding items in **SCIA Engineer**. Also shown is a table of how physical **Revit** objects are transferred between **Revit** and **SCIA Engineer**. Refer to the topic on the *Bi-Directional Link between Revit and SCIA Engineer*.